

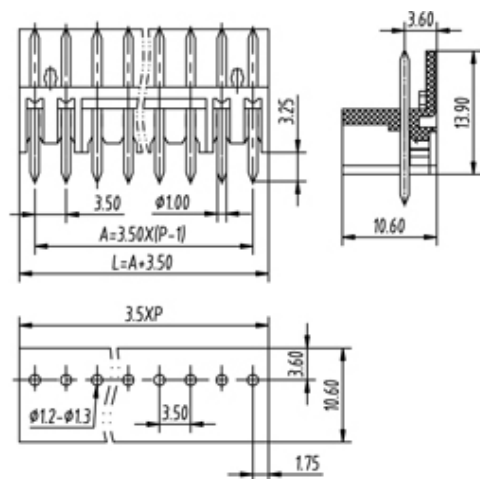

# Pluggable Pin Header (Male) - Single Row PCB Header

Range: PCB Terminal Blocks, Connectors and Fuse Holders

Part Number: TL007P-20PK



## DESCRIPTION

20 Pole Pin header Vertical 3.5mm pitch 10A 300V

*Subject to technical modification without notice.*

*Typographical and other errors do not justify claim for damages.*

## SPECIFICATION

<b>Connection Method</b>	Pin header
<b>Mounting Type</b>	Vertical
<b>Orientation</b>	Vertical
<b>Join</b>	Solid body non stackable
<b>Pitch (mm)</b>	3.5
<b>Number of Poles</b>	20
<b>Max Current (A)</b>	10
<b>Max Voltage (V)</b>	300
<b>Height (mm)</b>	13.9
<b>Standard Colour</b>	Black
<b>Width (mm)</b>	10.6
<b>Length (mm)</b>	70
<b>Solder Pin Length (mm)</b>	3.25
<b>PCB Hole Diameter (mm)</b>	1.2-1.3
<b>Body Material</b>	PA66 V0
<b>Min Temperature Rating °C</b>	-40
<b>Max Temperature Rating °C</b>	125