

# Pluggable Pin Header (Male) - Single Row PCB Header

Range: PCB Terminal Blocks, Connectors and Fuse Holders

Order Code: TLPHW-200V-16P

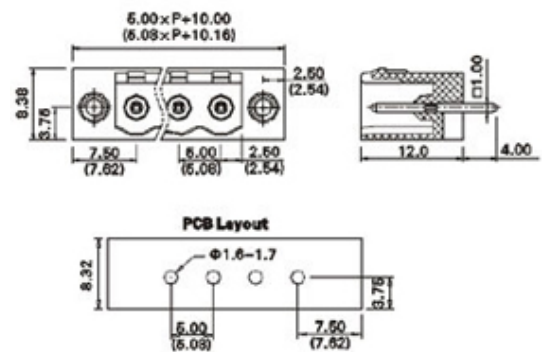
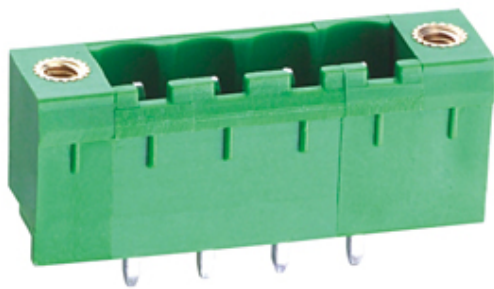

## DESCRIPTION

16 Pole PCB mount - Male header Wave - through hole Vertical 5mm pitch 16A(UL) 15A(VDE) 300V(UL) 250V(VDE)

*Subject to technical modification without notice.*

*Typographical and other errors do not justify claim for damages.*

## SPECIFICATION

Type	PCB mount - Male header
Mounting Type	Wave - through hole
Orientation	Vertical
Join	Solid body non stackable
Pitch (mm)	5
Open/Closed/Screw/Flange	Screw Flange
Number of Poles	16
Max Current (A)	16A(UL) 15A(VDE)
Max Voltage (V)	300V(UL) 250V(VDE)
Height (mm)	12
Standard Colour	Green
Width (mm)	8.45
Length (mm)	90
Solder Pin Length (mm)	4
PCB Hole Diameter (mm)	1.6-1.7
Body Material	PA66 V0
Comments	Pole sizes / no of ways not shown, please contact us for availability
Min Temperature Rating °C	-40
Max Temperature Rating °C	105

## INDUSTRY ACCREDITATIONS

