

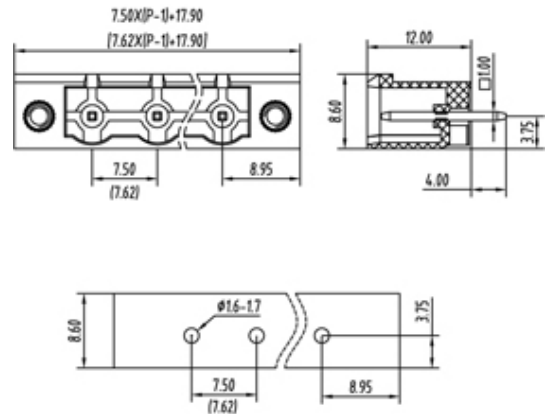

# Pluggable Pin Header (Male) - Single Row PCB Header

Range: PCB Terminal Blocks, Connectors and Fuse Holders

Order Code: TLPHW-400V-16P



## DESCRIPTION

16 Pole PCB mount - Male header Wave - through hole Vertical 7.5mm pitch 16A(UL) 15A(VDE) 300V(UL) 450V(VDE)

*Subject to technical modification without notice.  
Typographical and other errors do not justify claim for damages.*

## SPECIFICATION

<b>Type</b>	PCB mount - Male header
<b>Mounting Type</b>	Wave - through hole
<b>Orientation</b>	Vertical
<b>Join</b>	Solid body non stackable
<b>Pitch (mm)</b>	7.5
<b>Open/Closed/Screw/Flange</b>	Screw Flange
<b>Number of Poles</b>	16
<b>Max Current (A)</b>	16A(UL) 15A(VDE)
<b>Max Voltage (V)</b>	300V(UL) 450V(VDE)
<b>Height (mm)</b>	12
<b>Standard Colour</b>	Green
<b>Width (mm)</b>	8.6
<b>Length (mm)</b>	130.4
<b>Solder Pin Length (mm)</b>	4
<b>PCB Hole Diameter (mm)</b>	1.6-1.7
<b>Body Material</b>	PA66 V0
<b>Comments</b>	Pole sizes / no of ways not shown, please contact us for availability
<b>Min Temperature Rating °C</b>	-40
<b>Max Temperature Rating °C</b>	105

## INDUSTRY ACCREDITATIONS

