

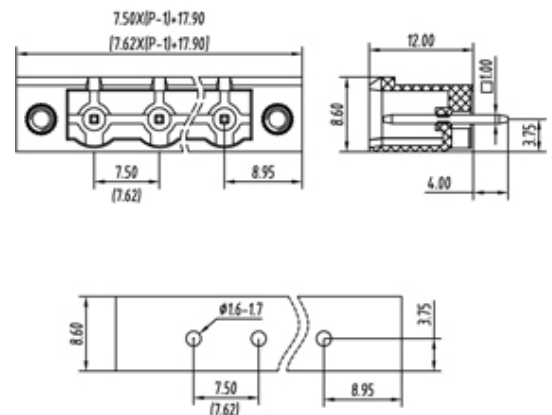

# Pluggable Pin Header (Male) - Single Row PCB Header

Range: PCB Terminal Blocks, Connectors and Fuse Holders

Order Code: TLPHW-400V-23P



## DESCRIPTION

23 Pole PCB mount - Male header Wave - through hole Vertical 7.5mm pitch 16A(UL) 15A(VDE) 300V(UL) 450V(VDE)

*Subject to technical modification without notice.*

*Typographical and other errors do not justify claim for damages.*

## SPECIFICATION

|                                  |   |
|----------------------------------|---|
| <b>Type</b>                      | PCB mount - Male header   |
| <b>Mounting Type</b>             | Wave - through hole   |
| <b>Orientation</b>               | Vertical  |
| <b>Join</b>                      | Solid body non stackable  |
| <b>Pitch (mm)</b>                | 7.5   |
| <b>Open/Closed/Screw/Flange</b>  | Screw Flange  |
| <b>Number of Poles</b>           | 23  |
| <b>Max Current (A)</b>           | 16A(UL) 15A(VDE)  |
| <b>Max Voltage (V)</b>           | 300V(UL) 450V(VDE)  |
| <b>Height (mm)</b>               | 12  |
| <b>Standard Colour</b>           | Green   |
| <b>Width (mm)</b>                | 8.6   |
| <b>Length (mm)</b>               | 182.9   |
| <b>Solder Pin Length (mm)</b>    | 4   |
| <b>PCB Hole Diameter (mm)</b>    | 1.6-1.7   |
| <b>Body Material</b>             | PA66 V0   |
| <b>Comments</b>                  | Pole sizes / no of ways not shown, please contact us for availability |
| <b>Min Temperature Rating °C</b> | -40   |
| <b>Max Temperature Rating °C</b> | 105   |

## INDUSTRY ACCREDITATIONS

