

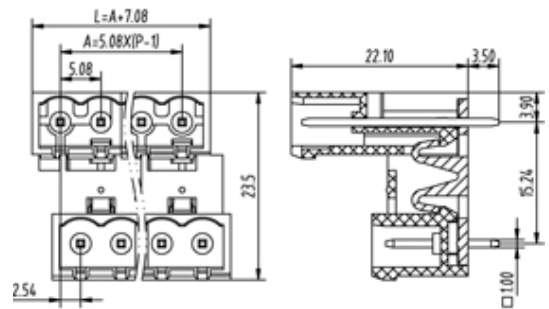

# Pluggable Pin Header (Male) - Double Decker PCB Header

Range: PCB Terminal Blocks, Connectors and Fuse Holders

Part Number: TLPHDC-303V-28P

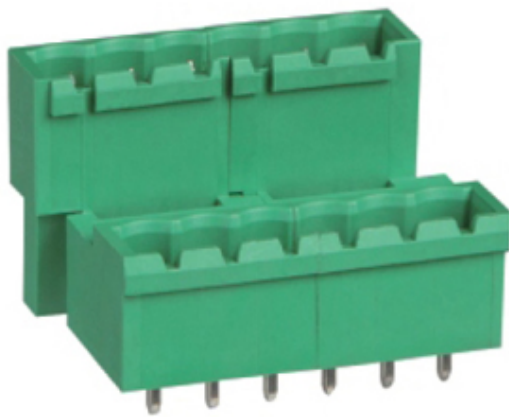

## DESCRIPTION

28 Pole Pluggable type Vertical 5.08mm pitch 16A 300V

*Subject to technical modification without notice.*

*Typographical and other errors do not justify claim for damages.*

## SPECIFICATION

<b>Connection Method</b>	Pluggable type
<b>Mounting Type</b>	Vertical
<b>Orientation</b>	Vertical
<b>Join</b>	Solid body non stackable
<b>Pitch (mm)</b>	5.08
<b>Number of Poles</b>	28
<b>Max Current (A)</b>	16
<b>Max Voltage (V)</b>	300
<b>Height (mm)</b>	23.5
<b>Standard Colour</b>	GREEN
<b>Width (mm)</b>	22.1
<b>Length (mm)</b>	75.66
<b>Solder Pin Length (mm)</b>	3.5
<b>Body Material</b>	PA66 V0