

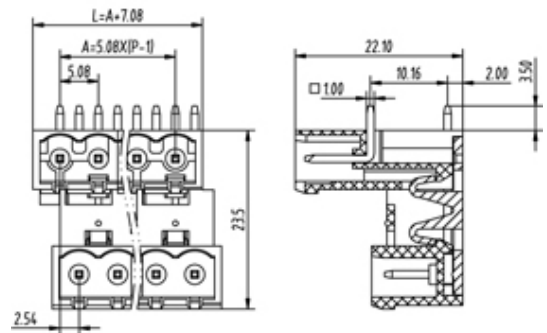

Pluggable Pin Header (Male) - Double Decker PCB Header

Range: PCB Terminal Blocks, Connectors and Fuse Holders

Part Number: TLP HDC-303R-36P

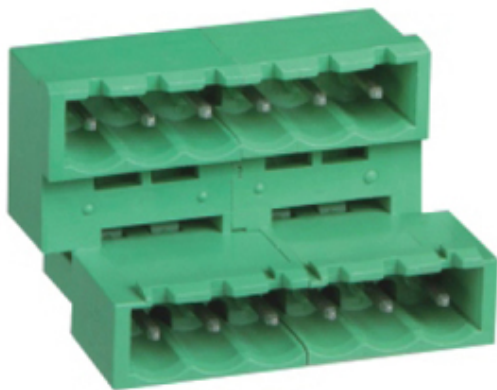

DESCRIPTION

36 Pole Pluggable type Vertical Horizontal 5.08mm pitch 16A 300V

Subject to technical modification without notice.

Typographical and other errors do not justify claim for damages.

SPECIFICATION

| | |
|-------------------------------|--------------------------|
| Connection Method | Pluggable type |
| Mounting Type | Vertical |
| Orientation | Horizontal |
| Join | Solid body non stackable |
| Pitch (mm) | 5.08 |
| Number of Poles | 36 |
| Max Current (A) | 16 |
| Max Voltage (V) | 300 |
| Height (mm) | 23.5 |
| Standard Colour | GREEN |
| Width (mm) | 22.1 |
| Length (mm) | 95.98 |
| Solder Pin Length (mm) | 3.5 |
| Body Material | PA66 V0 |