

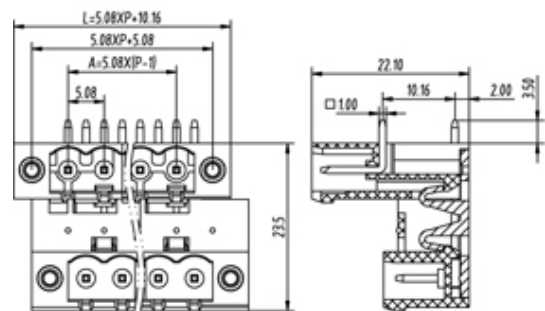

Pluggable Pin Header (Male) - Double Decker PCB Header

Range: PCB Terminal Blocks, Connectors and Fuse Holders

Part Number: TLPHDW-303R-12P

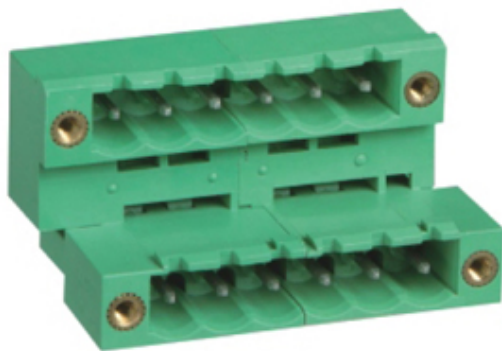

DESCRIPTION

12 Pole Pluggable type Vertical Horizontal 5.08mm pitch 16A 300V

Subject to technical modification without notice.

Typographical and other errors do not justify claim for damages.

SPECIFICATION

Connection Method	Pluggable type
Mounting Type	Vertical
Orientation	Horizontal
Join	Solid body non stackable
Pitch (mm)	5.08
Number of Poles	12
Max Current (A)	16
Max Voltage (V)	300
Height (mm)	23.5
Standard Colour	GREEN
Width (mm)	22.1
Length (mm)	43.18
Solder Pin Length (mm)	3.5
Body Material	PA66 V0