

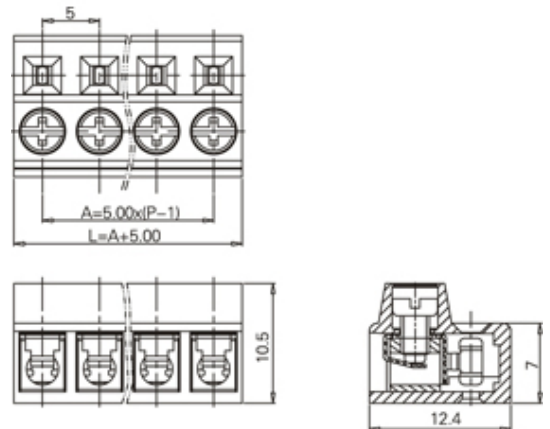

Pluggable Cable Mounting - Pluggable (Female)

Range: PCB Terminal Blocks, Connectors and Fuse Holders

Part Number: TL222T-11PKS



DESCRIPTION

11 Pole Wire Protector Vertical 5mm pitch 10A 300V

Subject to technical modification without notice.

Typographical and other errors do not justify claim for damages.

SPECIFICATION

Connection Method	Wire Protector
Mounting Type	Vertical
Orientation	Vertical
Join	Solid body non stackable
Pitch (mm)	5
Number of Poles	11
Max Current (A)	10
Max Voltage (V)	300
Height (mm)	10.5
Standard Colour	Black
Width (mm)	12.4
Length (mm)	55
Body Material	PA66 V0