

Pluggable Cable Mounting - Pluggable (Female)

Range: PCB Terminal Blocks, Connectors and Fuse Holders

Part Number: TLPS-003-16P

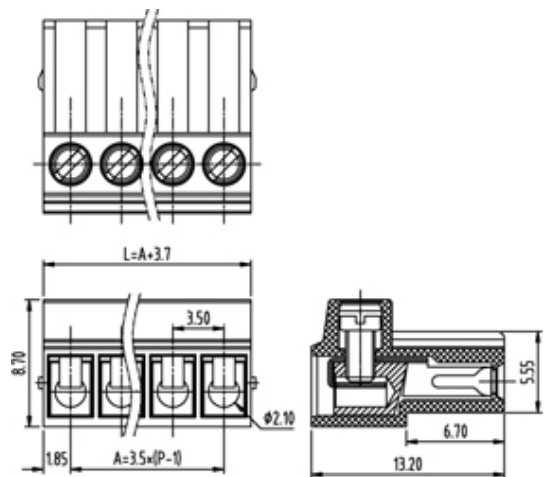

DESCRIPTION

16 Pole Pluggable type Horizontal 3.5mm pitch 10A(UL) 300V(UL)

Subject to technical modification without notice.

Typographical and other errors do not justify claim for damages.

SPECIFICATION

Connection Method	Pluggable type
Mounting Type	Horizontal
Orientation	Horizontal
Join	Solid body non stackable
Pitch (mm)	3.5
Number of Poles	16
Max Current (A)	10A(UL)
Max Voltage (V)	300V(UL)
Height (mm)	8.7
Standard Colour	Black
Width (mm)	13.2
Length (mm)	56.2
Body Material	PA66 V0