

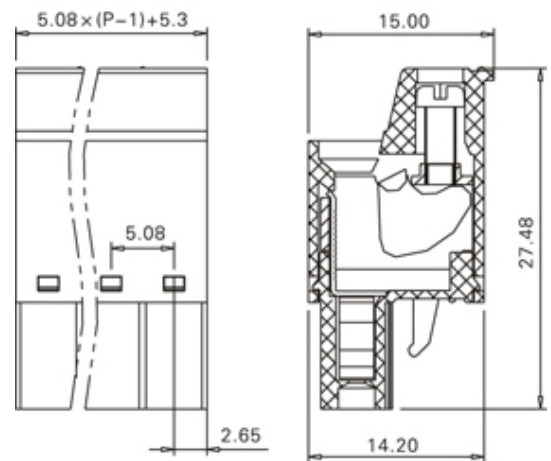

# Pluggable Cable Mounting - Pluggable (Female)

Range: PCB Terminal Blocks, Connectors and Fuse Holders

Order Code: TLPS-301V-13P



## DESCRIPTION

13 Pole Cable mount - Female plug Screw Rising clamp Vertical 5.08mm pitch 16A(UL) 300V(UL)

*Subject to technical modification without notice.*

*Typographical and other errors do not justify claim for damages.*

## SPECIFICATION

<b>Type</b>	Cable mount - Female plug
<b>Connection Method</b>	Screw
<b>Mounting Type</b>	Rising clamp
<b>Orientation</b>	Vertical
<b>Join</b>	Solid body non stackable
<b>Pitch (mm)</b>	5.08
<b>Number of Poles</b>	13
<b>Min Wire Size (Sq mm)</b>	0.08
<b>Max Wire Size (Sq mm)</b>	2.5
<b>Max Current (A)</b>	16A(UL)
<b>Max Voltage (V)</b>	300V(UL)
<b>Height (mm)</b>	27.48
<b>Standard Colour</b>	Green
<b>Width (mm)</b>	15
<b>Length (mm)</b>	66.26
<b>Approvals Pending</b>	UL Pending
<b>Body Material</b>	PA66 V0
<b>Comments</b>	Pole sizes / no of ways not shown, please contact us for availability
<b>Min Temperature Rating °C</b>	-40
<b>Max Temperature Rating °C</b>	105
<b>Min Wire Size AWG</b>	28
<b>Max Wire Size AWG</b>	12

## INDUSTRY ACCREDITATIONS

