

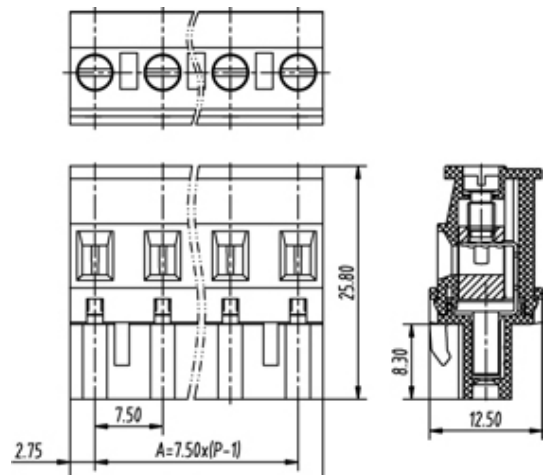

Pluggable Cable Mounting - Pluggable (Female)

Range: PCB Terminal Blocks, Connectors and Fuse Holders

Part Number: TLPS-400R-05P



DESCRIPTION

5 Pole Pluggable type Vertical 7.5mm pitch 16A(UL) 300V(UL)

Subject to technical modification without notice.

Typographical and other errors do not justify claim for damages.

SPECIFICATION

Connection Method	Pluggable type
Mounting Type	Vertical
Orientation	Vertical
Join	Solid body non stackable
Pitch (mm)	7.5
Number of Poles	5
Max Current (A)	16A(UL)
Max Voltage (V)	300V(UL)
Height (mm)	25.8
Width (mm)	12.5
Length (mm)	35.5
Body Material	PA66 V0