

Pluggable Cable Mounting - Pluggable (Female)

Range: PCB Terminal Blocks, Connectors and Fuse Holders

Order Code: TLPSW-001R-19P

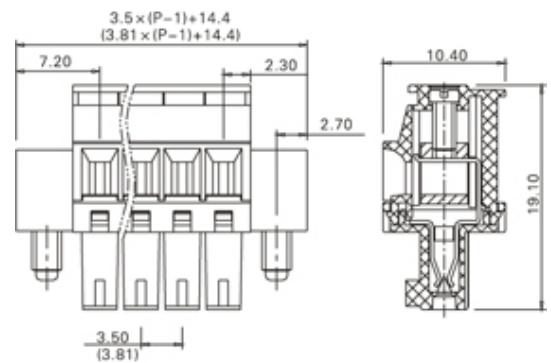
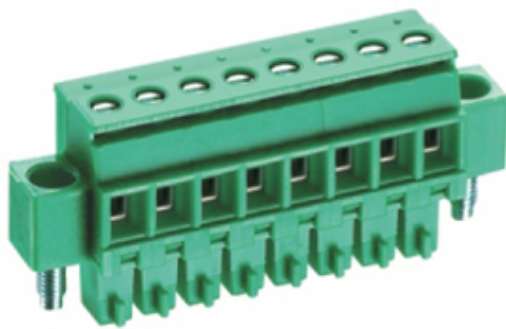

DESCRIPTION

19 Pole Cable mount - Female plug Screw Rising clamp Horizontal 3.5mm pitch 8A(UL) 300V(UL)

Subject to technical modification without notice.

Typographical and other errors do not justify claim for damages.

SPECIFICATION

| | |
|----------------------------------|---|
| Type | Cable mount - Female plug |
| Connection Method | Screw |
| Mounting Type | Rising clamp |
| Orientation | Horizontal |
| Join | Solid body non stackable |
| Pitch (mm) | 3.5 |
| Open/Closed/Screw/Flange | Screw Flange |
| Number of Poles | 19 |
| Min Wire Size (Sq mm) | 0.25 |
| Max Wire Size (Sq mm) | 2.5 |
| Max Current (A) | 8A(UL) |
| Max Voltage (V) | 300V(UL) |
| Height (mm) | 19.1 |
| Standard Colour | Green |
| Width (mm) | 10.4 |
| Length (mm) | 77.4 |
| Body Material | PA66 V0 |
| Comments | Pole sizes / no of ways not shown, please contact us for availability |
| Min Temperature Rating °C | -40 |
| Max Temperature Rating °C | 105 |
| Min Wire Size AWG | 24 |
| Max Wire Size AWG | 14 |

INDUSTRY ACCREDITATIONS

