

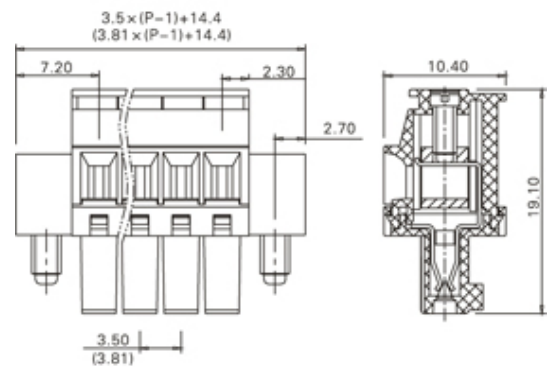

# Pluggable Cable Mounting - Pluggable (Female)

Range: PCB Terminal Blocks, Connectors and Fuse Holders

Order Code: TLPSW-100RL-23P



## DESCRIPTION

23 Pole Cable mount - Female plug Screw Rising clamp Horizontal 3.81mm pitch 8A(UL) 300V(UL)

*Subject to technical modification without notice.*

*Typographical and other errors do not justify claim for damages.*

## SPECIFICATION

|                                  |   |
|----------------------------------|---|
| <b>Type</b>                      | Cable mount - Female plug   |
| <b>Connection Method</b>         | Screw   |
| <b>Mounting Type</b>             | Rising clamp  |
| <b>Orientation</b>               | Horizontal  |
| <b>Join</b>                      | Solid body non stackable  |
| <b>Pitch (mm)</b>                | 3.81  |
| <b>Open/Closed/Screw/Flange</b>  | Screw Flange  |
| <b>Number of Poles</b>           | 23  |
| <b>Min Wire Size (Sq mm)</b>     | 0.25  |
| <b>Max Wire Size (Sq mm)</b>     | 2.5   |
| <b>Max Current (A)</b>           | 8A(UL)  |
| <b>Max Voltage (V)</b>           | 300V(UL)  |
| <b>Height (mm)</b>               | 19.1  |
| <b>Standard Colour</b>           | Green   |
| <b>Width (mm)</b>                | 10.4  |
| <b>Length (mm)</b>               | 98.22   |
| <b>Body Material</b>             | PA66 V0   |
| <b>Comments</b>                  | Pole sizes / no of ways not shown, please contact us for availability |
| <b>Min Temperature Rating °C</b> | -40   |
| <b>Max Temperature Rating °C</b> | 105   |
| <b>Min Wire Size AWG</b>         | 24  |
| <b>Max Wire Size AWG</b>         | 14  |

## INDUSTRY ACCREDITATIONS

