

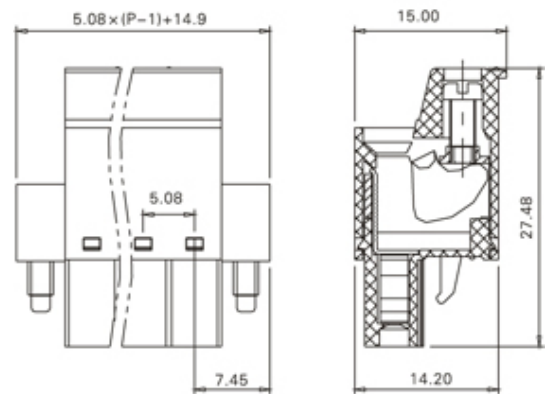

Pluggable Cable Mounting - Pluggable (Female)

Range: PCB Terminal Blocks, Connectors and Fuse Holders

Order Code: TLPSW-301V-16P



DESCRIPTION

16 Pole Cable mount - Female plug Screw Rising clamp Vertical 5.08mm pitch 16A(UL) 300V(UL)

Subject to technical modification without notice.

Typographical and other errors do not justify claim for damages.

SPECIFICATION

Type	Cable mount - Female plug
Connection Method	Screw
Mounting Type	Rising clamp
Orientation	Vertical
Join	Solid body non stackable
Pitch (mm)	5.08
Open/Closed/Screw/Flange	Screw Flange
Number of Poles	16
Min Wire Size (Sq mm)	0.08
Max Wire Size (Sq mm)	2.5
Max Current (A)	16A(UL)
Max Voltage (V)	300V(UL)
Height (mm)	27.48
Standard Colour	Green
Width (mm)	15
Length (mm)	91.1
Approvals Pending	UL Pending
Body Material	PA66 V0
Comments	Pole sizes / no of ways not shown, please contact us for availability
Min Temperature Rating °C	-40
Max Temperature Rating °C	105
Min Wire Size AWG	28
Max Wire Size AWG	12

INDUSTRY ACCREDITATIONS

