

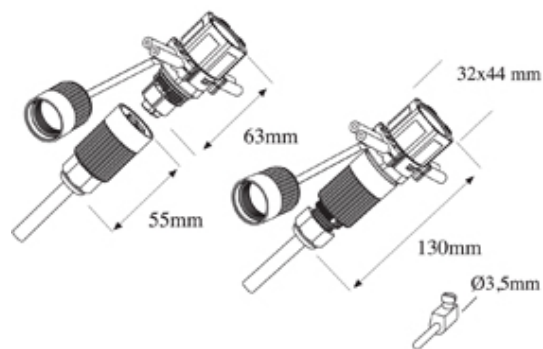

TeePlug & Sockets

Range: Weatherproof/Waterproof Connectors

Order Code: THF.388.A3A



DESCRIPTION

TeePlug 3 pole Crimp terminal, 1.5 mm max conductor size IP20 17.5A
400V 1 cable entry

WEATHERPROOF/WATERPROOF CONNECTORS FEATURES

- Up to IP68 versions available
- Various configurations available
- Components are keyway coded to ensure correct assembly
- All products are quick and simple to install
- Bulkhead/chassis mount options available (depending on product type)
- Temperature range of -20°C to +125°C

Features may vary by product throughout the range.

Subject to technical modification without notice.

Typographical and other errors do not justify claim for damages.

SPECIFICATION

Type	Plug
Cable Entries	1
Max Current (A)	17.5
Max Voltage (V)	400
Number of Poles	3
Min Conductor Size (Sq mm)	0.5
Max Conductor Size (Sq mm)	1.5
IP Rating	20
Min Temperature Rating °C	-40
Max Temperature Rating °C	125
Temperature "T" Rating	T125
Body Material	PA66
Fixing System	Cable
Terminal Type	Crimp

INDUSTRY ACCREDITATIONS

